

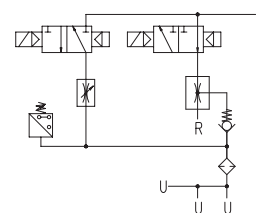

MULTI-STAGE AND MULTI-FUNCTION VACUUM GENERATORS MVG 3 and MVG 7

3D drawings are available on vuototecnica.net

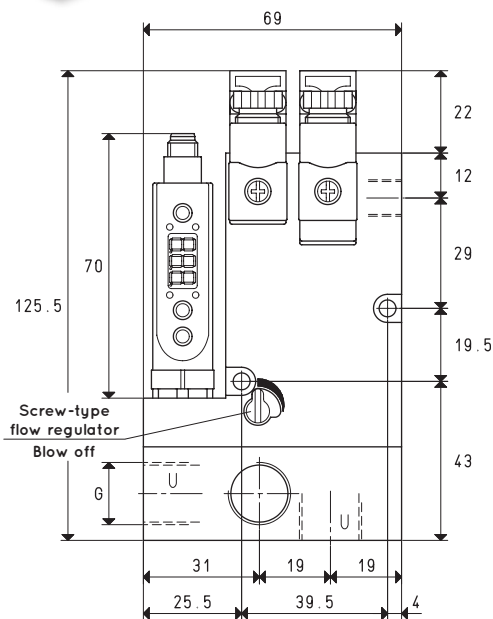
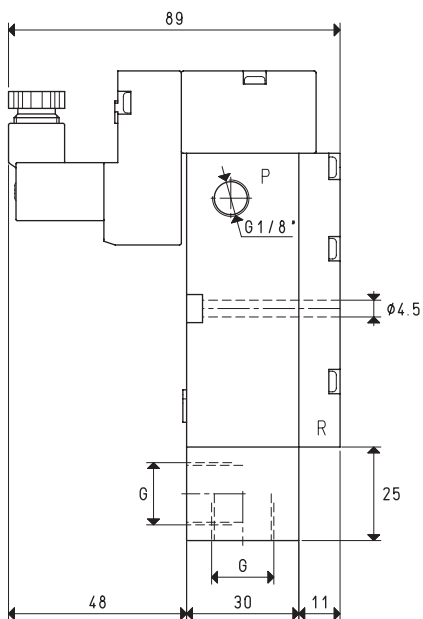

P=COMPRESSED AIR CONNECTION R=EXHAUST U=VACUUM CONNECTION

Item		MVG 3			MVG 7		
Intake air flow rate	m ³ /h	2.8	3.0	3.2	5.6	6.0	6.6
Maximum level of vacuum	-KPa	50	70	85	50	70	85
Final pressure	mbar abs.	500	300	150	500	300	150
Supply pressure	bar	3	4	5	3	4	5
Optimal supply pressure	bar			5			5
Air consumption	NI/s	0.5	0.6	0.8	0.8	1.0	1.3
Max quantity of air blown at 5 bar	l/min			205			205
Supply solenoid valve position	NO/NC			NO			NO
Ejection solenoid valve position	NC			NC			NC
Supply voltage	V			24 DC			24 DC
Electrical absorption	W			1 x 2			1 x 2
Vacuum switch output				PNP			PNP
Degree of protection	IP			65			65
Temperature of use	°C			-10 / +60			-10 / +60
Noise level at optimal supply pressure	dB(A)			66			70
Weight	Kg			0.666			0.670
G	Ø			G1/4"			G3/8"

Note: To order a generator with NC supply solenoid valve, indicate item code MVG .. NC.

Without digital vacuum switch, indicate code MVG .. SV.

Without ejection solenoid valve, indicate code MVG .. SC.

Note: All vacuum values indicated in the table are valid at the normal atmospheric pressure of 1013 mbar and obtained with a constant supply pressure.

Vacuum generator supply must be carried out with non-lubricated compressed air, 5 micron filtration, in accordance with standard ISO 8573-1 class 4.

Transformation ratio: N (newton) = Kg x 9.81 (force of gravity)

inch = $\frac{\text{mm}}{25.4}$; pounds = $\frac{\text{g}}{453.6} = \frac{\text{Kg}}{0.4536}$

Adapters for GAS - NPT threading available on page 1.130



Air flow rate (NI/s) at different level of vacuum (-KPa) at optimal supply pressure

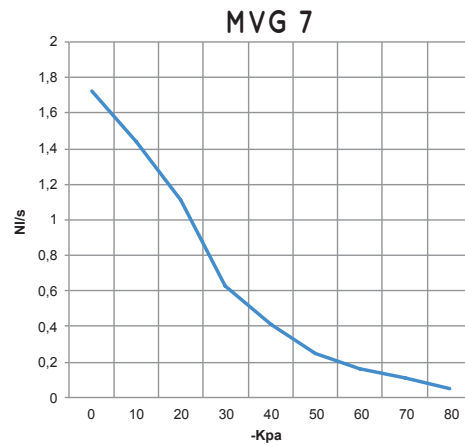
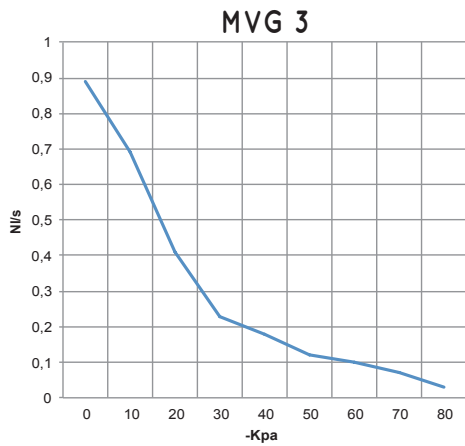

Generator item	Supp. press. bar	Air consumption NI/s	Air flow rate (NI/s) at different levels of vacuums (-KPa) at optimal supply pressure										Max vacuum -KPa
			0	10	20	30	40	50	60	70	80		
MVG 3	5.0	0.8	0.89	0.69	0.41	0.23	0.18	0.12	0.10	0.07	0.03	85	
MVG 7	5.0	1.3	1.83	1.44	1.11	0.63	0.41	0.25	0.16	0.11	0.05	85	

Evacuation rates (ms/l = s/m³) at different levels of vacuums (-KPa) at optimal supply pressure

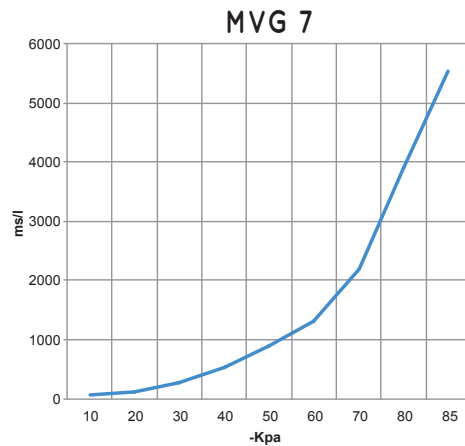
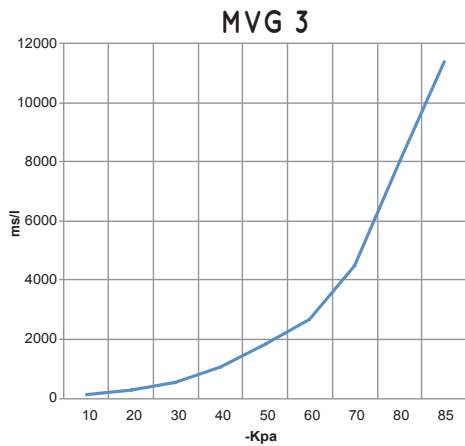

Generator item	Supp. press. bar	Air consumption NI/s	Evacuation rates (ms/l= s/m³) at different levels of vacuums (-KPa) at optimal supply pressure										Max vacuum -KPa
			10	20	30	40	50	60	70	80	85		
MVG 3	5.0	0.8	119	274	552	1088	1845	2694	4499	8009	11373	85	
MVG 7	5.0	1.3	58	133	268	529	897	1310	2188	3895	5531	85	

ACCESSORIES AND SPARE PARTS UPON REQUEST

Item		MVG 3	MVG 7
Sealing kit and reed valves	item	00 KIT MVG 3	00 KIT MVG 7
Exhaust silencer	item		00 15 150
Electrical connection cable with axial connector, for vacuum switch	item		00 12 20
Electrical connection cable with radial connector, for vacuum switch	item		00 12 21
Set of electrical connection cables, with built-in NO energy saving device and connectors	item		00 15 202
Set of electrical connection cables, with built-in NC energy saving device and connectors	item		00 15 203
Digital vacuum switch	item		12 10 10
NO supply solenoid valve	item		00 15 436
NC supply solenoid valve	item		00 15 437