



VACUUM JET FLOW GENERATORS

Working principle

The compressed air supply blown into a ring chamber concentric to the device, flows at a very high speed towards the centre of the main pipe, thus forming a cyclonic effect. The latter creates a vacuum inside the device and leads a great volume of air towards its outlet.

Therefore, a variation of the air supply pressure will modify the level of vacuum and the amount of sucked air.

Features

The special shape of the flow generators and their straight-flow working principle allow for the suctioning and handling of various nature products without interference. Vacuum Jets are in fact suitable for the handling of powders, granulated products, sawdust, corn, metal chips, liquid or dry food products, etc., or for extracting fumes, coolant mists, water or oil condensation, etc.

The absence of moving parts allows them to be used continuously, without developing heat.

They do not require electricity; therefore, they can be used in work environments with hazardous environments where an ignition source would be dangerous.

Available in anodised aluminium and stainless steel.

Thanks to all these features, a good filtration of the compressed air supply will be sufficient to make these devices fully maintenance-free.

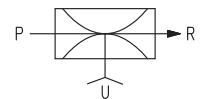
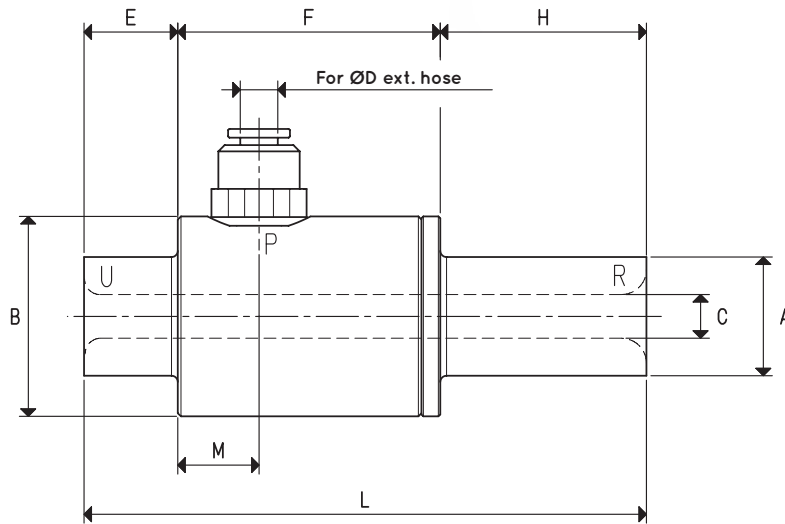

P=COMPRESSED AIR CONNECTION R=EXHAUST U=VACUUM CONNECTION

Item		CX 7	CX 10
Max quantity of intake air at 6 bar	m ³ /h	12.0	28.0
Max quantity of air blown at 6 bar	m ³ /h	17.6	36.2
Maximum level of vacuum	-KPa	15	22
Final pressure	abs. mbar	850	780
Maximum supply pressure	bar	6	6
Maximum air consumption at 6 bar	NI/s	1.5	2.3
Temperature of use	°C	-20 / +80	-20 / +80
Noise level	dB(A)	75	84
Weight	g	110	104
A	∅	19	19
B	∅	32	32
C	∅	7	10
D	∅	6	6
E		15	15
F		42	42
H		33	33
L		90	90
M		13	13

Note: All vacuum values indicated in the table are valid at the normal atmospheric pressure of 1013 mbar and obtained with a constant supply pressure.

Add the letter I, to the item for a generator supplied in stainless steel (Example: CX 10 I).

Vacuum generator supply must be carried out with non-lubricated compressed air, 5 micron filtration, in accordance with standard ISO 8573-1 class 4.

Transformation ratio: N (newton) = Kg x 9.81 (force of gravity)

inch = $\frac{\text{mm}}{25.4}$; pounds = $\frac{\text{g}}{453.6} = \frac{\text{Kg}}{0.4536}$

Adapters for GAS - NPT threading available on page 1.130



Quantity of air suctioned (m^3/h) at different supply pressures (bar)

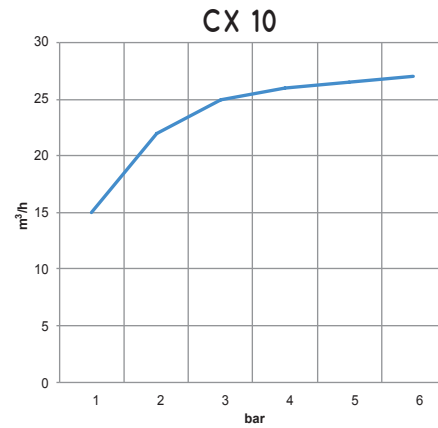
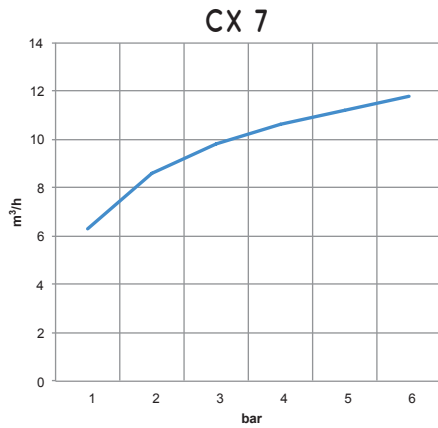

Quantity of air blown (m^3/h) at different supply pressures (bar)

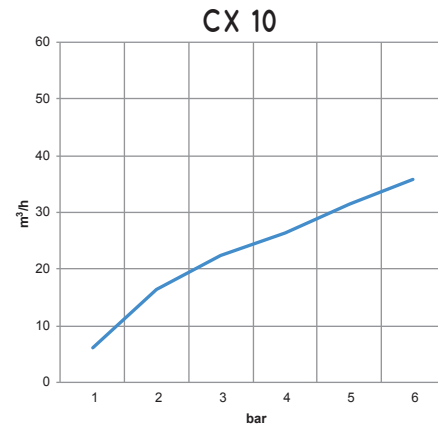
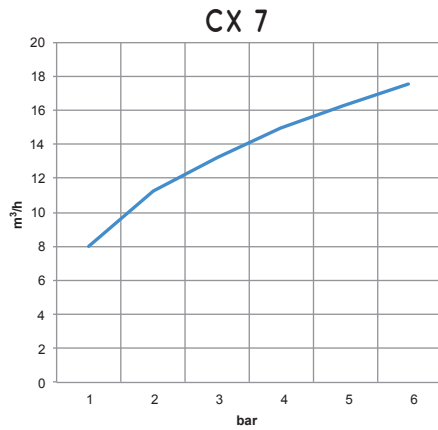

Level of vacuum (-Kpa) at different supply pressures (bar)

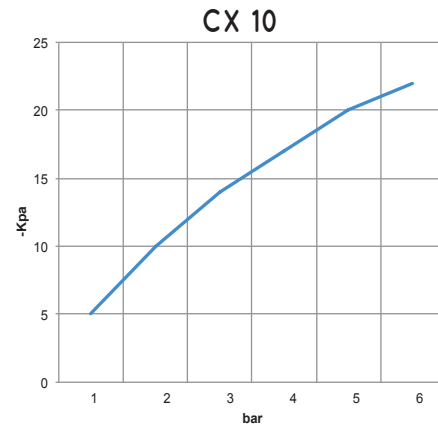
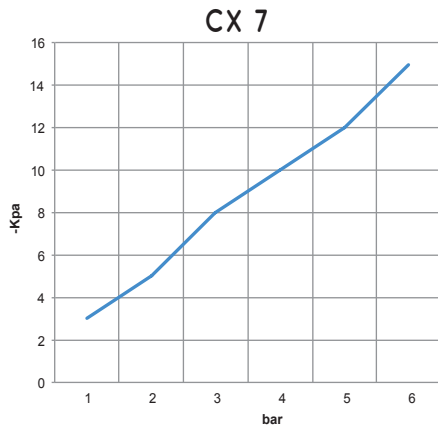

Air consumption (Nl/s) at different supply pressures (bar)

